

# STUDIO

LED MIRRORS 26/27



REMER



# ABOUT STUDIO

The Remer Studio Range brings together sculptural mirror design and advanced technology to create mirrors that enhance everyday spaces.

Twenty-seven distinctive designs explore the relationship between form, light, and reflection, each developed to complement contemporary interiors.

Every mirror is assembled locally in Melbourne using **Guardian Glass UltraMirror® Plus**, featuring an **integrated demister**, **Remer's Seamless Lighting technology**, and built with the RCM certified **ModuBox system** to deliver a refined and enduring lighting experience.

Made to order in Melbourne  
Estimated lead time: 2 weeks\*



DEMISTER



GUARDIAN GLASS ULTRAMIRROR® PLUS

PICTURED FRONT COVER: Cove Page 10-11

# MODUBOX

BUILT TO LAST

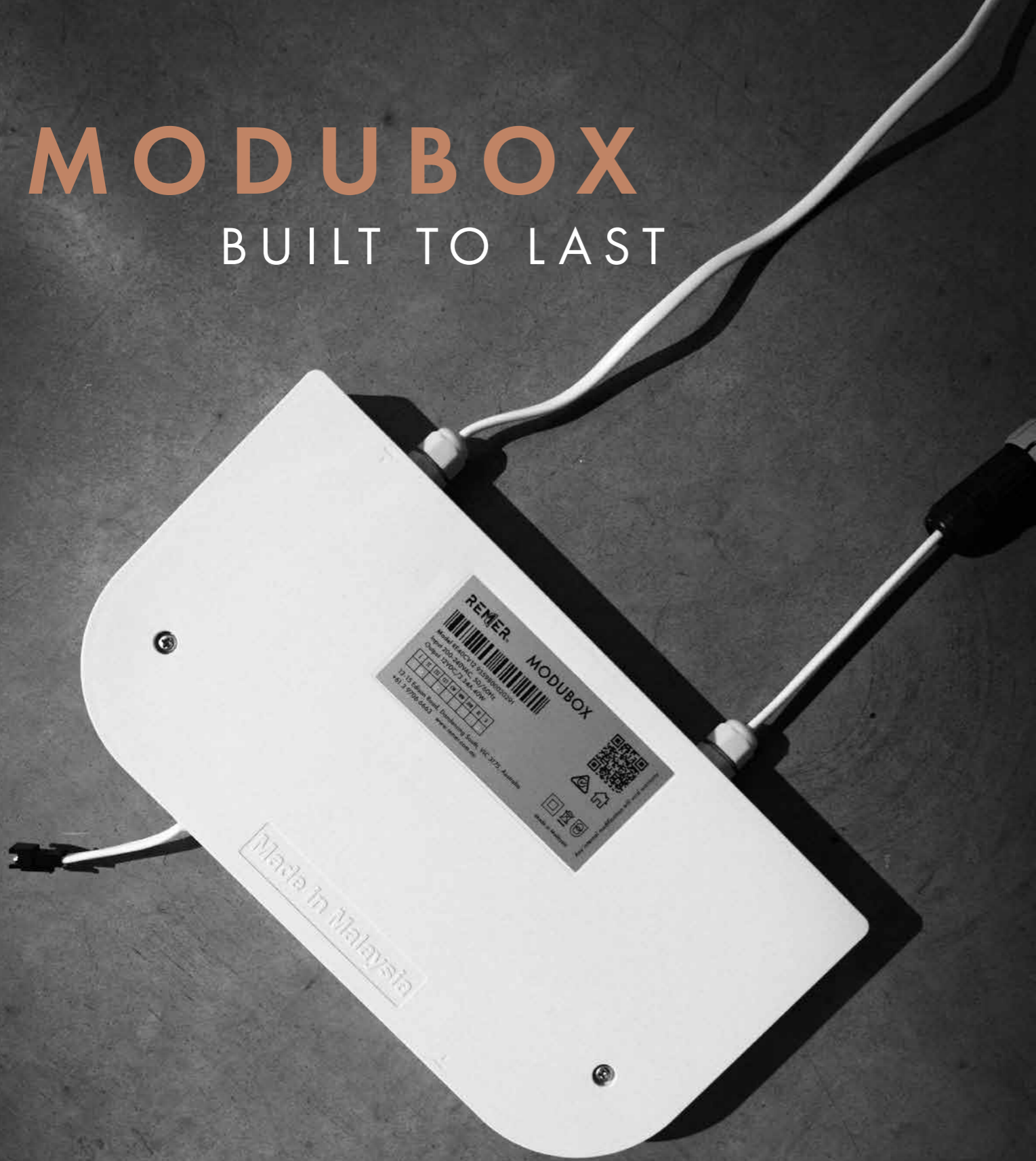

At the core of every Remer mirror is the RCM certified **ModuBox system**, an engineered modular backing that has been developed as part of our move to Australian manufacturing.

This considered construction allows key components to be accessed and serviced individually, without replacing the entire mirror, supporting long-term performance and longevity.

The ModuBox system also conceals electrical components within a clean, structured backing, enhancing both safety and visual clarity. Designed to meet all relevant electrical standards, it provides confidence in both installation and ongoing use.

Not only are Remer mirrors designed to look exceptional from the front, but every detail behind the mirror has been carefully considered to reduce clutter, improve safety, and ensure a refined finish from every angle.

- ✓ RCM certified ModuBox system
- ✓ Smarter engineering
- ✓ Enhanced safety & longevity
- ✓ Simplified installation and servicing
- ✓ Fully enclosed electrical components
- ✓ Flicker-free performance



# SEAMLESS LIGHTING

## FLAWLESS ILLUMINATION

- ✓ A steady, refined glow
- ✓ Always seamless, off or on
- ✓ Edge to edge illumination
- ✓ Higher LED density for brightness

As part of our transition to Australian manufacturing, the Remer Studio Range was reimagined to deliver a mirror that not only performs, but enhances the space around it.

**Seamless LED Lighting** introduces a refined approach to illumination, replacing the harsh appearance of individual LED points with a smooth, continuous line of light. The result is a softer, more balanced glow that is gentle on the eye while providing consistent, even illumination.

Designed to sit cleanly against the wall, the lighting integrates effortlessly into the mirror form, creating a more resolved and architectural finish.



### DOTTED LED

- Uneven light distribution
- 120 LEDs per metre
- CRI 90
- Up to 12w per metre
- Up to 814 lumens per metre
- LED Lifetime >54,000 hours (L80)



### SEAMLESS LED

- Continuous, uniform illumination
- High-density 240 LEDs per metre
- Superior colour rendering CRI 90
- Up to 12w per metre
- High efficacy, up to 1182 lumens per metre
- LED Lifetime >54,000 hours (L80)

# HOW IT WORKS

## PERSONALISE YOUR MIRROR IN 3 STEPS

### 1 CHOOSE YOUR DESIGN & SIZE

Discover **27** distinctive mirror designs and select the size that best suits your space.

- **51** different shapes & sizes
- **7** aluminium frame colours, across **9** framed designs (frame code must be specified at time of order)

See page 8-9 for a comprehensive overview

### 2 CHOOSE A CONTROL

Studio mirrors allow you to choose how you interact with your mirror.

Choose one of:

- Touch Sensor with Guide Light
- Hand Wave Sensor

### 3 CHOOSE OPTIONAL ADD-ONS

Enhance your mirror with additional functionality.

- Bluetooth Speakers *and/or*
- Mirage Portable Magnifier

### FINALISING YOUR SELECTION

Your retailer will confirm your mirror selection, including design, control, and any optional add-ons.

Each option corresponds to a specific product code.

For example:

**AN50DF**

- + **CB** (Cuban Bronze Frame)
- + **C2** (Hand Wave Sensor)
- + **BT** (Bluetooth Speakers)
- + **AMX5MW** (Mirage Portable Makeup Mirror)



## CONTROL OPTIONS

Choose how you interact with your mirror (control code must be specified at time of order).

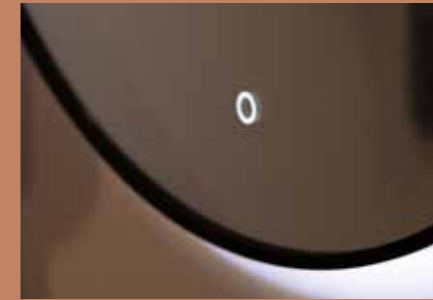

### TOUCH SENSOR WITH GUIDE LIGHT

A softly illuminated touch button integrated into the mirror surface for simple and precise control.

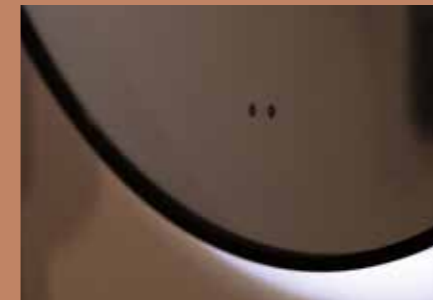

### HAND WAVE SENSOR

Activate the mirror with a gentle hand movement within 9cm of the sensor, offering a convenient way to operate the mirror without touching the glass.

## OPTIONAL ADD-ONS

Enhance your mirror with additional functionality (add-on code must be specified at time of order).



### BLUETOOTH SPEAKERS

Integrated speakers allow you to enjoy music, podcasts, or audio while getting ready.



### MIRAGE PORTABLE MAKEUP MAGNIFYING MIRROR

Adds magnified clarity for detailed grooming and makeup application.

# STUDIO SHAPES

Use this guide to quickly locate each design within the catalogue.

Use the icons below to identify the mirror category each style is available in:

- FRAMELESS  
Pages 10-47
- COLOURED GLASS  
Pages 48-51
- FRAMED  
Pages 52-63

## A-SERIES

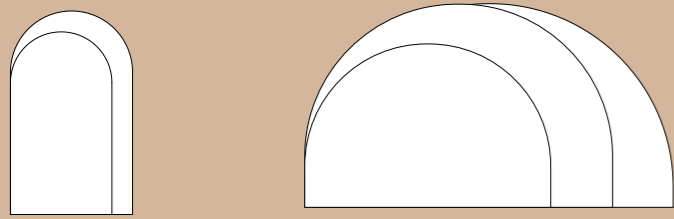

Page 12  Page 54

### COVE

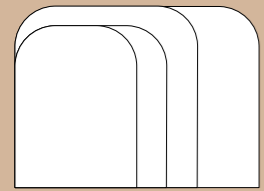

Page 14

### LUNA

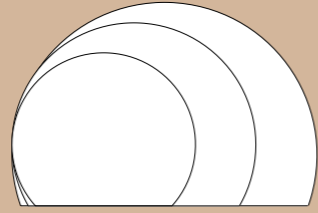

Page 16

## O-SERIES

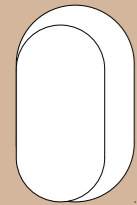

Page 18  Page 56

### INOX

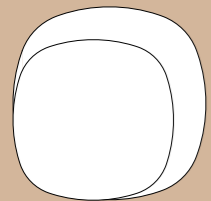

Page 22

## O-SERIES LANDSCAPE

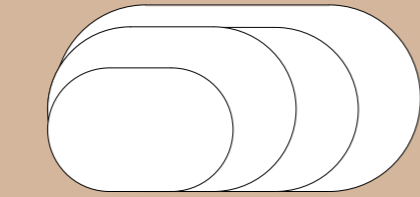

Page 20

### TURO

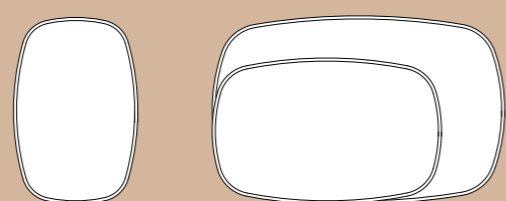

Page 24

## I-SERIES

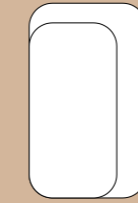

Page 26  Page 58

## W

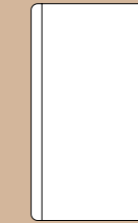

Page 30

## R-SERIES

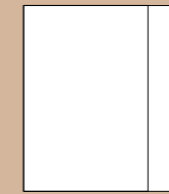

Page 32  Page 60

### DUO

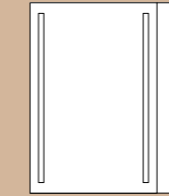

Page 36

## S-SERIES

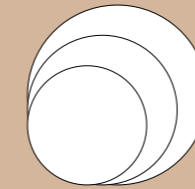

Page 40  Page 50  Page 62

### SORA

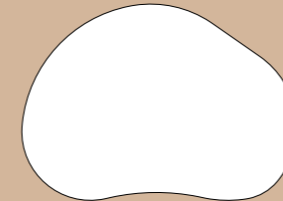

Page 44

## I -SERIES LANDSCAPE

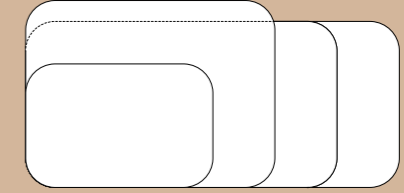

Page 28

## R-SERIES LANDSCAPE

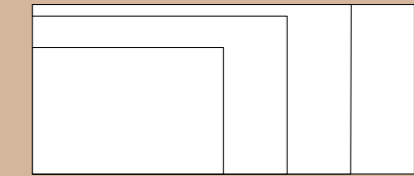

Page 34

### TRIO

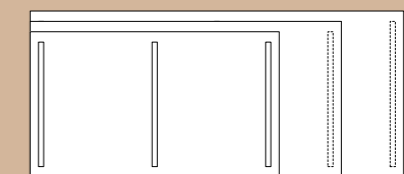

Page 38

## TERRA

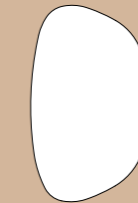

Page 42

### LANI

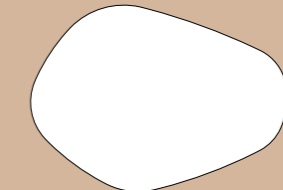

Page 46



# FRAMELESS MIRRORS

**CLEAN SILHOUETTES  
WITH UNINTERRUPTED  
EDGES THAT EMPHASISE  
FORM AND LIGHT.**



# A-SERIES

## FEATURES

- Seamless LED lighting
- Superior colour rendering: CRI 90
- High-density design: 240 LEDs/m
- LED Lifetime >54,000h L80
- Adjustable colour temperature: 2700K – 6500K
- Guardian Glass UltraMirror® Plus
- Demister
- 1 hour power saving cut off
- RCM certified IP44 rated ModuBox
- Backlit
- 5 Year replacement warranty

## CONTROL OPTIONS



## OPTIONAL ADD-ONS

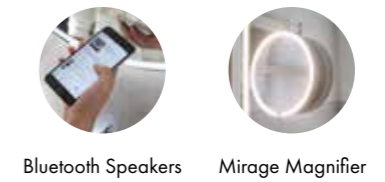

## SIZES + PRICING

	CODE	RRP INC GST
<b>1 CHOOSE YOUR SIZE</b>	500x900	AN50D \$429.00
	600x1000	AN60D \$657.00
	1200x800	AN120D \$825.00
	1500x1000	AN150D \$1,025.00
	1800x1000	AN180D \$1,219.00
<b>2 CHOOSE A CONTROL</b>	Touch Sensor with Guide Light	C1 -
	Hand Wave Sensor	C2 -
<b>3 CHOOSE ADD-ONS</b>	Bluetooth Speakers	BT \$159.00
	Mirage Magnifier	AMX5MW \$199.00

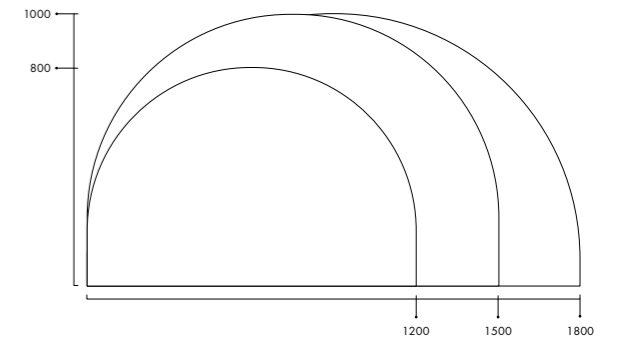
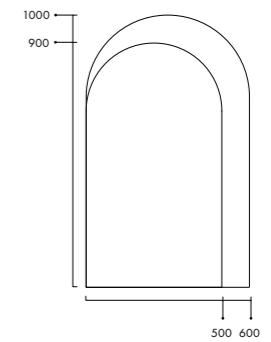



# COVE

## FEATURES

- Seamless LED lighting
- Superior colour rendering: CRI 90
- High-density design: 240 LEDs/m
- LED Lifetime >54,000h L80
- Adjustable colour temperature: 2700K – 6500K
- Guardian Glass UltraMirror® Plus
- Demister
- 1 hour power saving cut off
- RCM certified IP44 rated ModuBox
- Backlit
- 5 Year replacement warranty

## CONTROL OPTIONS

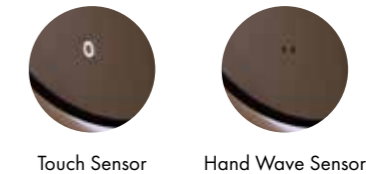

Touch Sensor      Hand Wave Sensor

## OPTIONAL ADD-ONS



Bluetooth Speakers      Mirage Magnifier

## SIZES + PRICING

	CODE	RRP INC GST
<b>1 CHOOSE YOUR SIZE</b>		
600x800	CVE60D	\$607.00
750x800	CVE75D	\$649.00
900x900	CVE90D	\$722.00
1200x900	CVE120D	\$855.00
<b>2 CHOOSE A CONTROL</b>		
Touch Sensor with Guide Light	C1	-
Hand Wave Sensor	C2	-
<b>3 CHOOSE ADD-ONS</b>		
Bluetooth Speakers	BT	\$159.00
Mirage Magnifier	AMX5MW	\$199.00

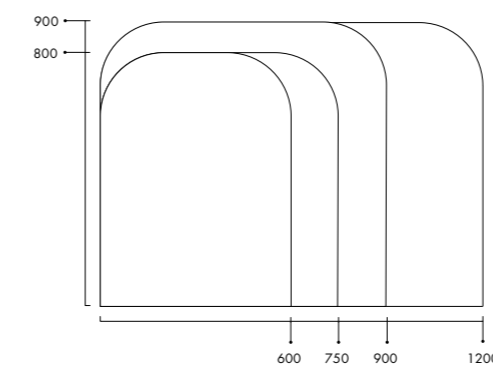



# LUNA

## FEATURES

- Seamless LED lighting
- Superior colour rendering: CRI 90
- High-density design: 240 LEDs/m
- LED Lifetime >54,000h L80
- Adjustable colour temperature: 2700K – 6500K
- Guardian Glass UltraMirror® Plus
- Demister
- 1 hour power saving cut off
- RCM certified IP44 rated ModuBox
- Backlit
- 5 Year replacement warranty

## CONTROL OPTIONS

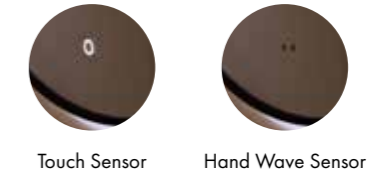

Touch Sensor      Hand Wave Sensor

## OPTIONAL ADD-ONS

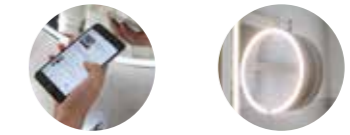

Bluetooth Speakers      Mirage Magnifier

## SIZES + PRICING

	CODE	RRP INC GST
<b>1 CHOOSE YOUR SIZE</b>		
900x750	LUN90D	\$695.00
1200x900	LUN120D	\$929.00
1500x1000	LUN150D	\$1,298.00
<b>2 CHOOSE A CONTROL</b>		
Touch Sensor with Guide Light	C1	-
Hand Wave Sensor	C2	-
<b>3 CHOOSE ADD-ONS</b>		
Bluetooth Speakers	BT	\$159.00
Mirage Magnifier	AMX5MW	\$199.00

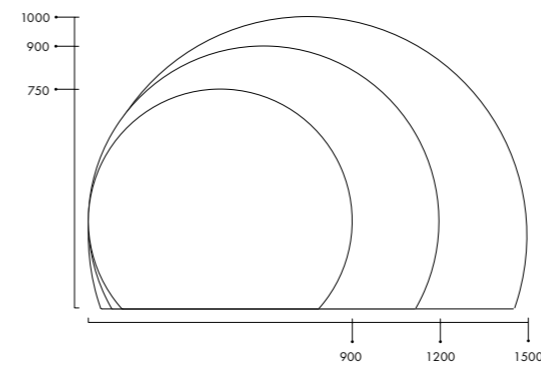



PICTURED: O-Series 450x900

# O-SERIES

FRAMELESS

## FEATURES

- Seamless LED lighting
- Superior colour rendering: CRI 90
- High-density design: 240 LEDs/m
- LED Lifetime >54,000h L80
- Adjustable colour temperature: 2700K – 6500K
- Guardian Glass UltraMirror® Plus
- Demister
- 1 hour power saving cut off
- RCM certified IP44 rated ModuBox
- Backlit
- 5 Year replacement warranty

## CONTROL OPTIONS

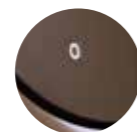

Touch Sensor

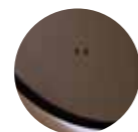

Hand Wave Sensor

## OPTIONAL ADD-ONS



Bluetooth Speakers



Mirage Magnifier

## SIZES + PRICING

### 1 CHOOSE YOUR SIZE

450x900  
600x1000

### 2 CHOOSE A CONTROL

Touch Sensor with Guide Light  
Hand Wave Sensor

### 3 CHOOSE ADD-ONS

Bluetooth Speakers  
Mirage Magnifier

CODE	RRP INC GST
ON45D	\$429.00
ON60D	\$657.00
C1	-
C2	-
BT	\$159.00
AMX5MW	\$199.00

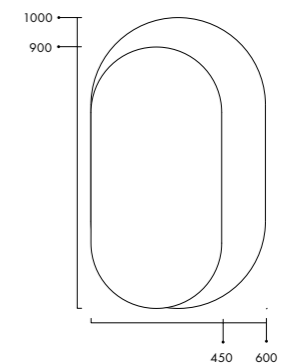



# O-SERIES LANDSCAPE

## FEATURES

- Seamless LED lighting
- Superior colour rendering: CRI 90
- High-density design: 240 LEDs/m
- LED Lifetime >54,000h L80
- Adjustable colour temperature: 2700K – 6500K
- Guardian Glass UltraMirror® Plus
- Demister
- 1 hour power saving cut off
- RCM certified IP44 rated ModuBox
- Backlit
- 5 Year replacement warranty

## CONTROL OPTIONS



## OPTIONAL ADD-ONS

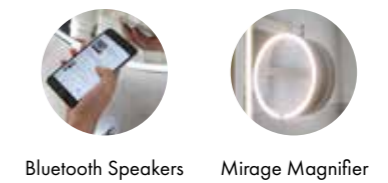

## SIZES + PRICING

	CODE	RRP INC GST
<b>1 CHOOSE YOUR SIZE</b>		
900x600	ON90D	\$657.00
1200x800	ON120D	\$868.00
1500x800	ON150D	\$1,095.00
1800x900	ON180D	\$1,197.00
<b>2 CHOOSE A CONTROL</b>		
Touch Sensor with Guide Light	C1	-
Hand Wave Sensor	C2	-
<b>3 CHOOSE ADD-ONS</b>		
Bluetooth Speakers	BT	\$159.00
Mirage Magnifier	AMX5MW	\$199.00

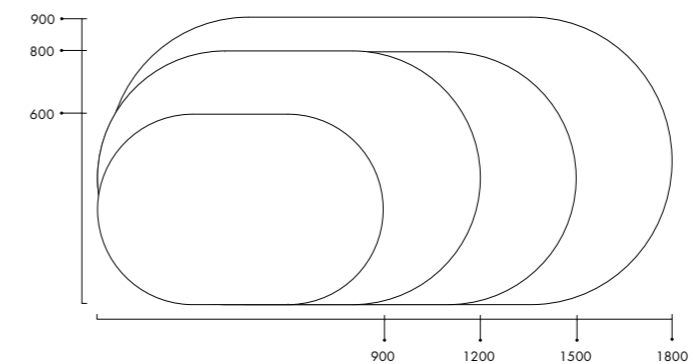



# INOX

## FEATURES

- Seamless LED lighting
- Superior colour rendering: CRI 90
- High-density design: 240 LEDs/m
- LED Lifetime >54,000h L80
- Adjustable colour temperature: 2700K – 6500K
- Guardian Glass UltraMirror® Plus
- Demister
- 1 hour power saving cut off
- RCM certified IP44 rated ModuBox
- Backlit
- 5 Year replacement warranty

## CONTROL OPTIONS

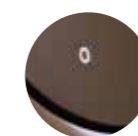

Touch Sensor

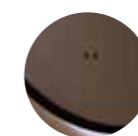

Hand Wave Sensor

## OPTIONAL ADD-ONS



Bluetooth Speakers

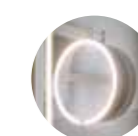

Mirage Magnifier

## SIZES + PRICING

	CODE	RRP INC GST
<b>1 CHOOSE YOUR SIZE</b>	800x800	\$519.00
	1000x1000	\$655.00
<b>2 CHOOSE A CONTROL</b>	Touch Sensor with Guide Light	C1
	Hand Wave Sensor	C2
<b>3 CHOOSE ADD-ONS</b>	Bluetooth Speakers	BT
	Mirage Magnifier	AMX5MW
		\$159.00
		\$199.00

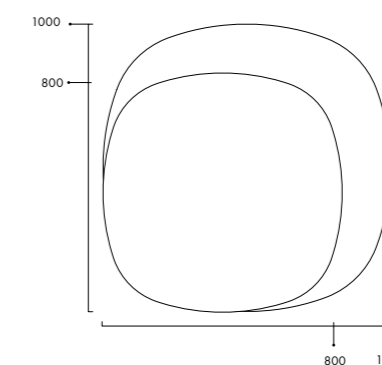



# TURO

## FEATURES

- Seamless LED lighting
- Superior colour rendering: CRI 90
- High-density design: 240 LEDs/m
- LED Lifetime >54,000h L80
- Adjustable colour temperature: 2700K – 6500K
- Guardian Glass UltraMirror® Plus
- Demister
- 1 hour power saving cut off
- RCM certified IP44 rated ModuBox
- Dual lit
- Clear edge
- 5 Year replacement warranty

## CONTROL OPTIONS

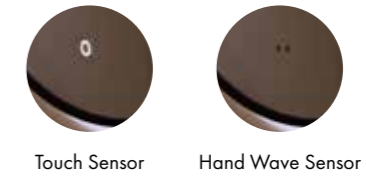

## OPTIONAL ADD-ONS



## SIZES + PRICING

	CODE	RRP INC GST
<b>1 CHOOSE YOUR SIZE</b>		
600x900	TU60D	\$529.00
1100x700	TU110DL	\$679.00
1400x900	TU140DL	\$829.00
<b>2 CHOOSE A CONTROL</b>		
Touch Sensor with Guide Light	C1	-
Hand Wave Sensor	C2	-
<b>3 CHOOSE ADD-ONS</b>		
Bluetooth Speakers	BT	\$159.00
Mirage Magnifier	AMX5MW	\$199.00

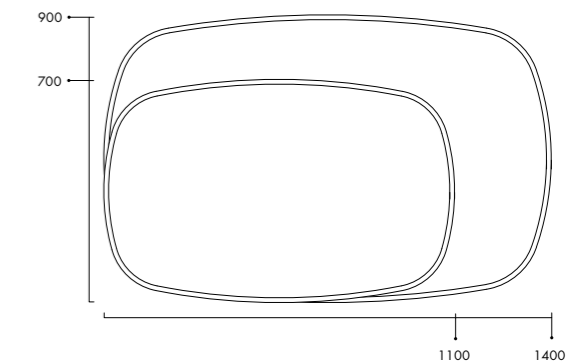
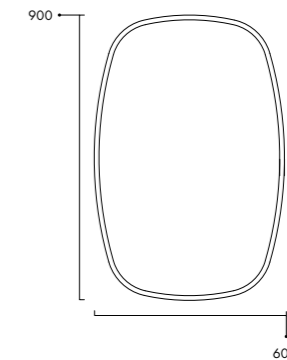



FRAMELESS

# I-SERIES



## FEATURES

- Seamless LED lighting
- Superior colour rendering: CRI 90
- High-density design: 240 LEDs/m
- LED Lifetime >54,000h L80
- Adjustable colour temperature: 2700K – 6500K
- Guardian Glass UltraMirror® Plus
- Demister
- 1 hour power saving cut off
- RCM certified IP44 rated ModuBox
- Backlit
- 5 Year replacement warranty

## CONTROL OPTIONS



Touch Sensor      Hand Wave Sensor

## OPTIONAL ADD-ONS



Bluetooth Speakers      Mirage Magnifier

## SIZES + PRICING

	CODE	RRP INC GST
<b>1 CHOOSE YOUR SIZE</b>	450x900	IN45D \$429.00
	600x1000	IN60D \$499.00
<b>2 CHOOSE A CONTROL</b>	Touch Sensor with Guide Light	C1 -
	Hand Wave Sensor	C2 -
<b>3 CHOOSE ADD-ONS</b>	Bluetooth Speakers	BT \$159.00
	Mirage Magnifier	AMX5MW \$199.00

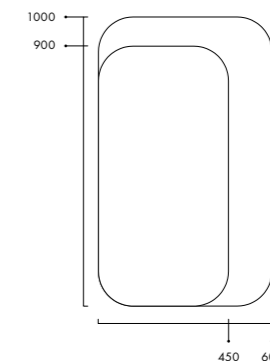



# I-SERIES LANDSCAPE

## FEATURES

- Seamless LED lighting
- Superior colour rendering: CRI 90
- High-density design: 240 LEDs/m
- LED Lifetime >54,000h L80
- Adjustable colour temperature: 2700K – 6500K
- Guardian Glass UltraMirror® Plus
- Demister
- 1 hour power saving cut off
- RCM certified IP44 rated ModuBox
- Backlit
- 5 Year replacement warranty

## CONTROL OPTIONS



Touch Sensor

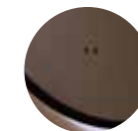

Hand Wave Sensor

## OPTIONAL ADD-ONS



Bluetooth Speakers

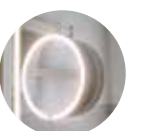

Mirage Magnifier

## SIZES + PRICING

	CODE	RRP INC GST
<b>1 CHOOSE YOUR SIZE</b>		
900x600	IN90D	\$585.00
1200x900	IN120D	\$769.00
1500x800	IN150D	\$986.00
1800x800	IN180D	\$1,295.00
<b>2 CHOOSE A CONTROL</b>		
Touch Sensor with Guide Light	C1	-
Hand Wave Sensor	C2	-
<b>3 CHOOSE ADD-ONS</b>		
Bluetooth Speakers	BT	\$159.00
Mirage Magnifier	AMX5MW	\$199.00

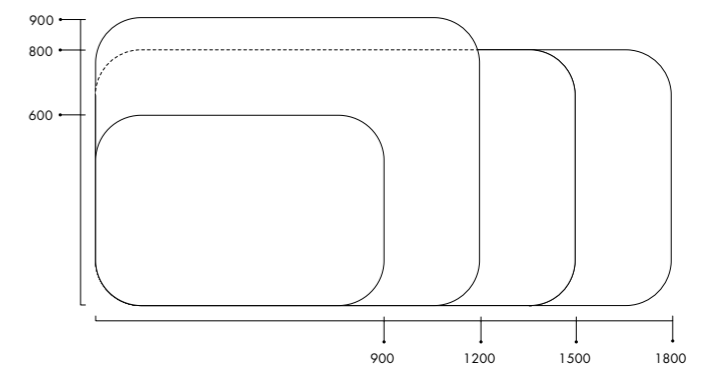



# W

## FEATURES

- Seamless LED lighting
- Superior colour rendering: CRI 90
- High-density design: 240 LEDs/m
- LED Lifetime >54,000h L80
- Adjustable colour temperature: 2700K – 6500K
- Guardian Glass UltraMirror® Plus
- Demister
- 1 hour power saving cut off
- RCM certified IP44 rated ModuBox
- Dual lit
- IP44
- 5 Year replacement warranty

## CONTROL OPTIONS

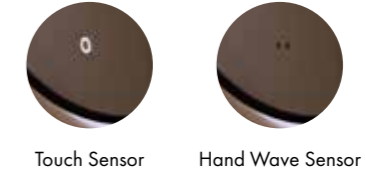

Touch Sensor Hand Wave Sensor

## OPTIONAL ADD-ONS



Bluetooth Speakers Mirage Magnifier

## SIZES + PRICING

	CODE	RRP INC GST
<b>1 CHOOSE YOUR SIZE</b>		
600x1000	W60D	\$857.00
900x750	W90D	\$749.00
1200x750	W120D	\$959.00
<b>2 CHOOSE A CONTROL</b>		
Touch Sensor with Guide Light	C1	-
Hand Wave Sensor	C2	-
<b>3 CHOOSE ADD-ONS</b>		
Bluetooth Speakers	BT	\$159.00
Mirage Magnifier	AMX5MW	\$199.00

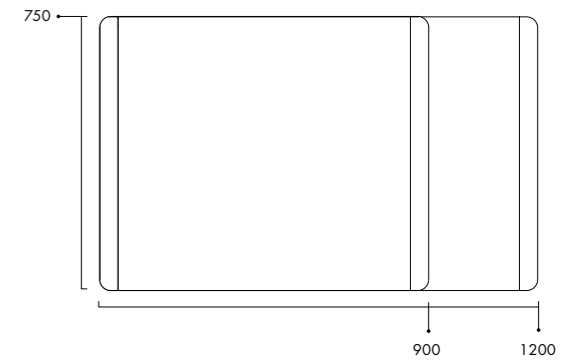
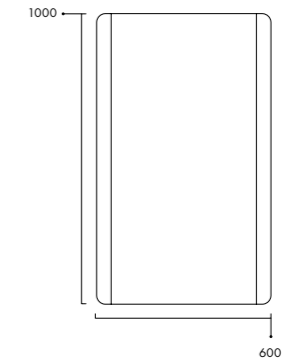

PICTURED: W 600x1000



PICTURED: R-Series 750x900

# R-SERIES

FRAMELESS

## FEATURES

- Seamless LED lighting
- Superior colour rendering: CRI 90
- High-density design: 240 LEDs/m
- LED Lifetime >54,000h L80
- Adjustable colour temperature: 2700K – 6500K
- Guardian Glass UltraMirror® Plus
- Demister
- 1 hour power saving cut off
- RCM certified IP44 rated ModuBox
- Backlit
- 5 Year replacement warranty

## CONTROL OPTIONS

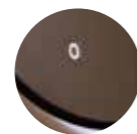

Touch Sensor

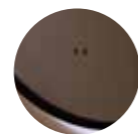

Hand Wave Sensor

## OPTIONAL ADD-ONS



Bluetooth Speakers

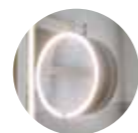

Mirage Magnifier

## SIZES + PRICING

	CODE	RRP INC GST
<b>1 CHOOSE YOUR SIZE</b>	600x900	\$499.00
	750x900	\$629.00
<b>2 CHOOSE A CONTROL</b>	Touch Sensor with Guide Light	-
	Hand Wave Sensor	-
<b>3 CHOOSE ADD-ONS</b>	Bluetooth Speakers	\$159.00
	Mirage Magnifier	\$199.00

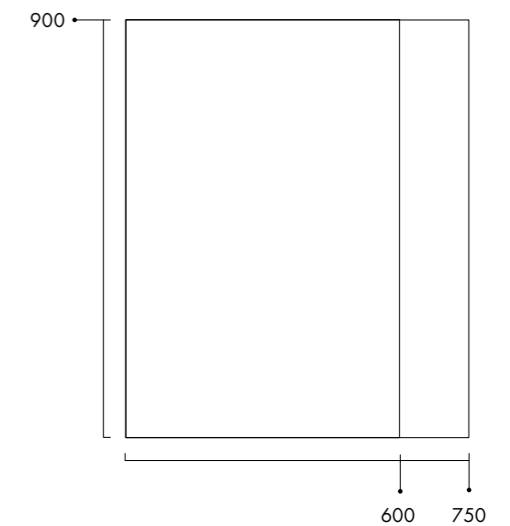



# R-SERIES LANDSCAPE

FRAMELESS



PICTURED: R-Series Landscape 1200x750

## FEATURES

- Seamless LED lighting
- Superior colour rendering: CRI 90
- High-density design: 240 LEDs/m
- LED Lifetime >54,000h L80
- Adjustable colour temperature: 2700K – 6500K
- Guardian Glass UltraMirror® Plus
- Demister
- 1 hour power saving cut off
- RCM certified IP44 rated ModuBox
- Backlit
- 5 Year replacement warranty

## CONTROL OPTIONS



Touch Sensor



Hand Wave Sensor

## OPTIONAL ADD-ONS



Bluetooth Speakers

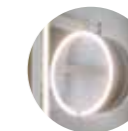

Mirage Magnifier

## SIZES + PRICING

	CODE	RRP INC GST
<b>1 CHOOSE YOUR SIZE</b>	900x600	RN90D \$499.00
	1200x750	RN120D \$639.00
	1500x800	RN150D \$926.00
	1800x800	RN180D \$1,098.00
	<b>2 CHOOSE A CONTROL</b>	Touch Sensor with Guide Light
Hand Wave Sensor		C2 -
<b>3 CHOOSE ADD-ONS</b>		Bluetooth Speakers
	Mirage Magnifier	AMX5MW \$199.00

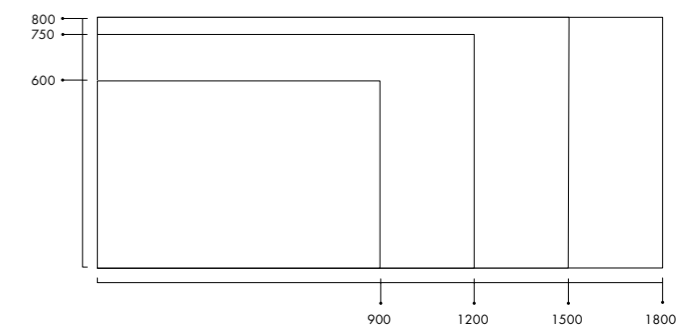

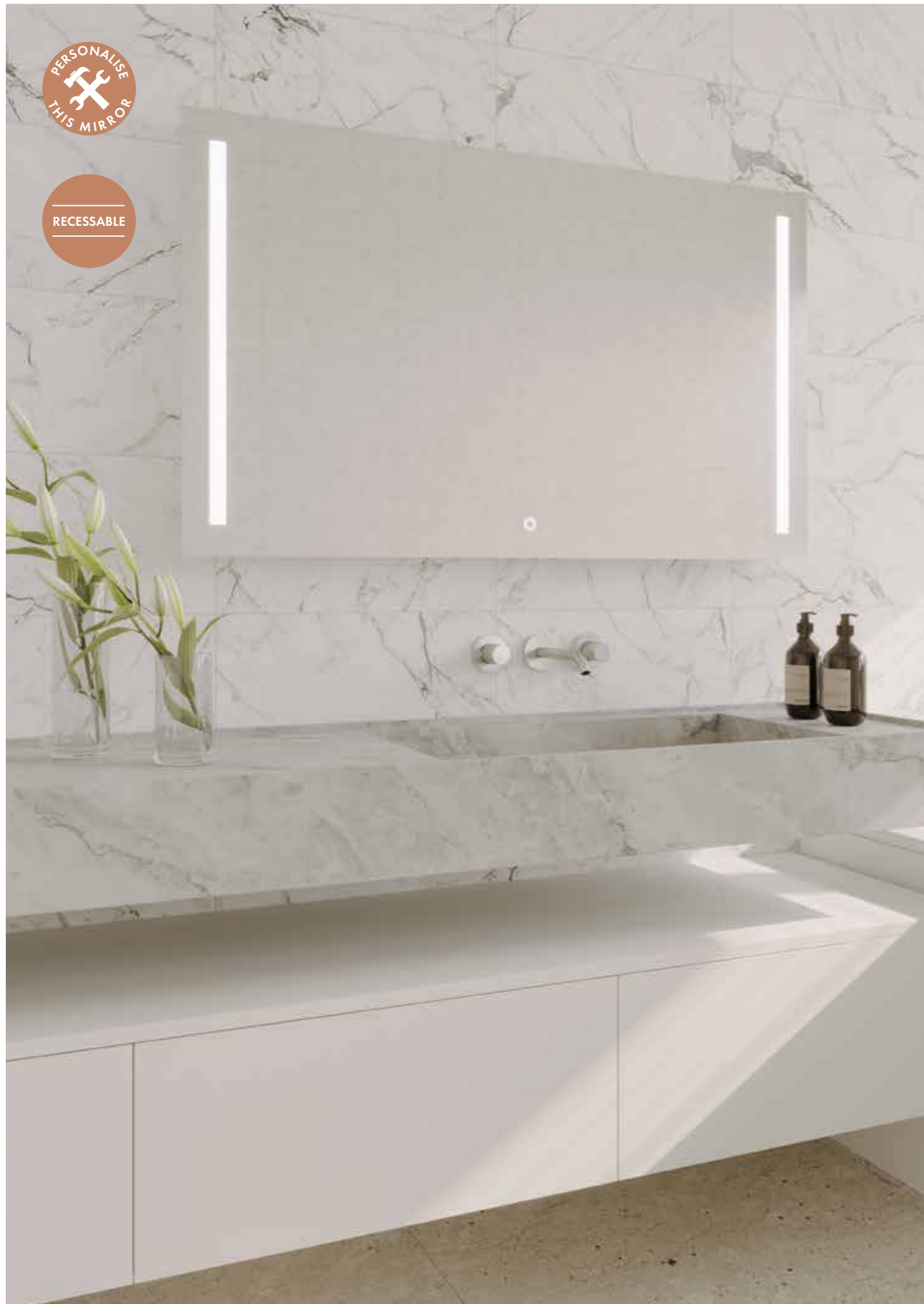

# DUO

## FEATURES

- Seamless LED lighting
- Superior colour rendering: CRI 90
- High-density design: 240 LEDs/m
- LED Lifetime >54,000h L80
- Adjustable colour temperature: 2700K – 6500K
- Guardian Glass UltraMirror® Plus
- Demister
- 1 hour power saving cut off
- RCM certified IP44 rated ModuBox
- Frontlit
- Recessable
- IP44
- 5 Year replacement warranty

## CONTROL OPTIONS

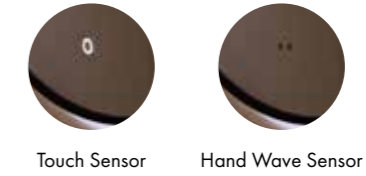

## OPTIONAL ADD-ONS

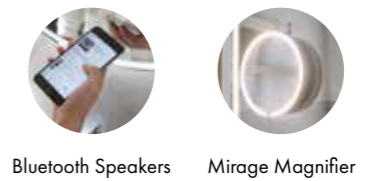

## SIZES + PRICING

	CODE	RRP INC GST
<b>1 CHOOSE YOUR SIZE</b>		
600x900	DU60D	\$489.00
750x900	DU75D	\$529.00
900x700	DU90D	\$579.00
1200x700	DU120D	\$719.00
<b>2 CHOOSE A CONTROL</b>		
Touch Sensor with Guide Light	C1	-
Hand Wave Sensor	C2	-
<b>3 CHOOSE ADD-ONS</b>		
Bluetooth Speakers	BT	\$159.00
Mirage Magnifier	AMX5MW	\$199.00

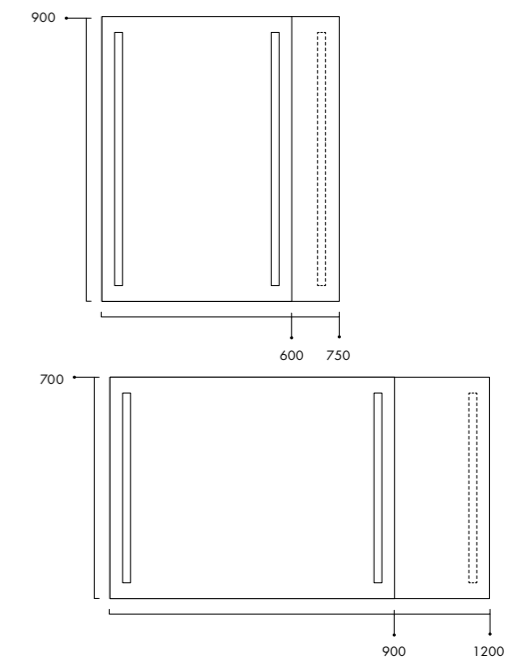

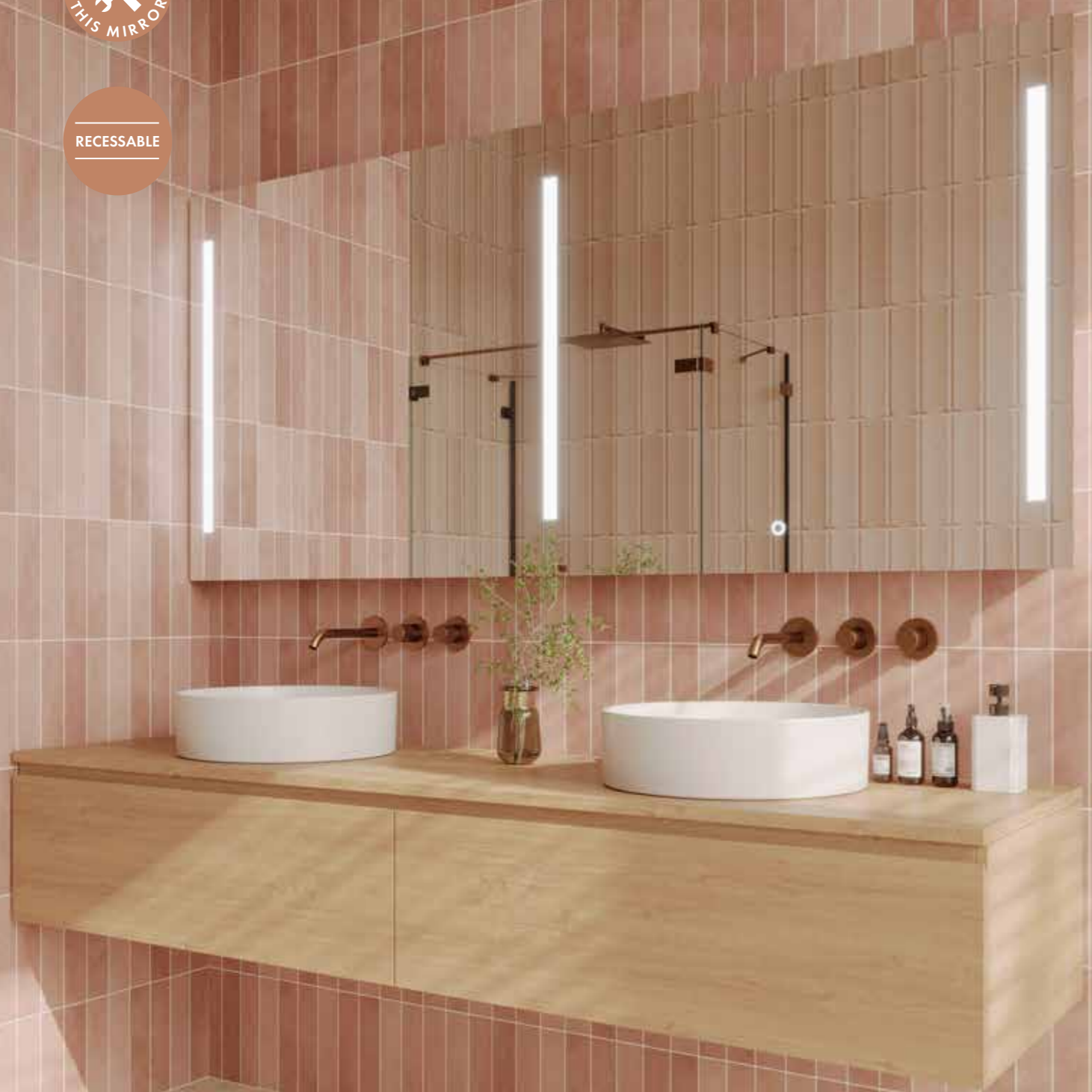

# TRIO

## FEATURES

- Seamless LED lighting
- Superior colour rendering: CRI 90
- High-density design: 240 LEDs/m
- LED Lifetime >54,000h L80
- Adjustable colour temperature: 2700K – 6500K
- Guardian Glass UltraMirror® Plus
- Demister
- 1 hour power saving cut off
- RCM certified IP44 rated ModuBox
- Frontlit
- Recessable
- IP44
- 5 Year replacement warranty

## CONTROL OPTIONS

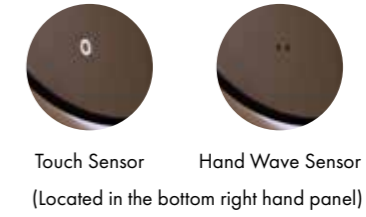

## OPTIONAL ADD-ONS



## SIZES + PRICING

	CODE	RRP INC GST
<b>1 CHOOSE YOUR SIZE</b>		
1200x700	TR120D	\$826.00
1500x750	TR150D	\$963.00
1800x800	TR180D	\$1,138.00
<b>2 CHOOSE A CONTROL</b>		
Touch Sensor with Guide Light	C1	-
Hand Wave Sensor	C2	-
<b>3 CHOOSE ADD-ONS</b>		
Bluetooth Speakers	BT	\$159.00
Mirage Magnifier	AMX5MW	\$199.00

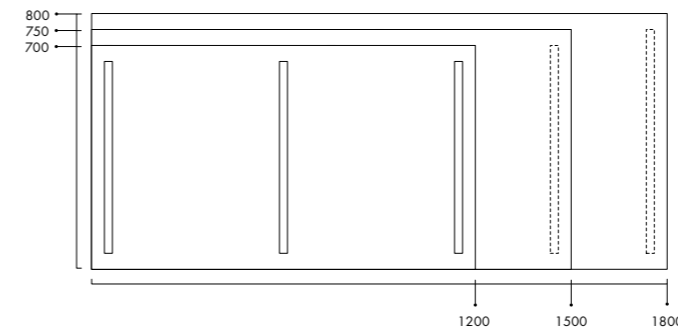



# S-SERIES

## FEATURES

- Seamless LED lighting
- Superior colour rendering: CRI 90
- High-density design: 240 LEDs/m
- LED Lifetime >54,000h L80
- Adjustable colour temperature: 2700K – 6500K
- Guardian Glass UltraMirror® Plus
- Demister
- 1 hour power saving cut off
- RCM certified IP44 rated ModuBox
- Backlit
- 5 Year replacement warranty

## CONTROL OPTIONS

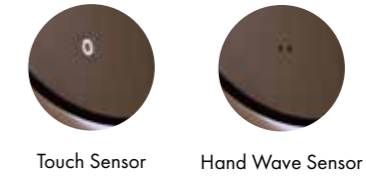

Touch Sensor      Hand Wave Sensor

## OPTIONAL ADD-ONS



Bluetooth Speakers      Mirage Magnifier

## SIZES + PRICING

	CODE	RRP INC GST
<b>1 CHOOSE YOUR SIZE</b>		
600x600	SN60D	\$299.00
800x800	SN80D	\$479.00
1000x1000	SN100D	\$868.00
<b>2 CHOOSE A CONTROL</b>		
Touch Sensor with Guide Light	C1	-
Hand Wave Sensor	C2	-
<b>3 CHOOSE ADD-ONS</b>		
Bluetooth Speakers	BT	\$159.00
Mirage Magnifier	AMX5MW	\$199.00

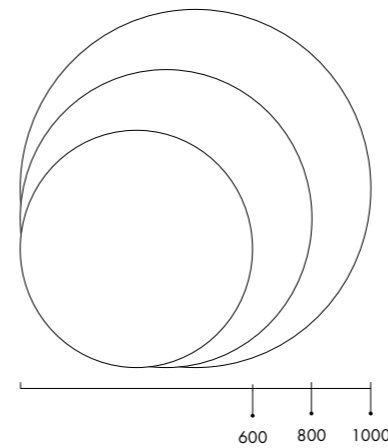



# TERRA

## FEATURES

- Seamless LED lighting
- Superior colour rendering: CRI 90
- High-density design: 240 LEDs/m
- LED Lifetime >54,000h L80
- Adjustable colour temperature: 2700K – 6500K
- Guardian Glass UltraMirror® Plus
- Demister
- 1 hour power saving cut off
- RCM certified IP44 rated ModuBox
- Backlit
- 5 Year replacement warranty

## CONTROL OPTIONS

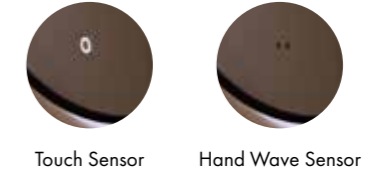

Touch Sensor    Hand Wave Sensor

## OPTIONAL ADD-ONS



Bluetooth Speakers    Mirage Magnifier

## SIZES + PRICING

	CODE	RRP INC GST
<b>1 CHOOSE YOUR SIZE</b> 600x1000	TE60D	\$595.00
<b>2 CHOOSE A CONTROL</b> Touch Sensor with Guide Light	C1	-
Hand Wave Sensor	C2	-
<b>3 CHOOSE ADD-ONS</b> Bluetooth Speakers	BT	\$159.00
Mirage Magnifier	AMX5MW	\$199.00

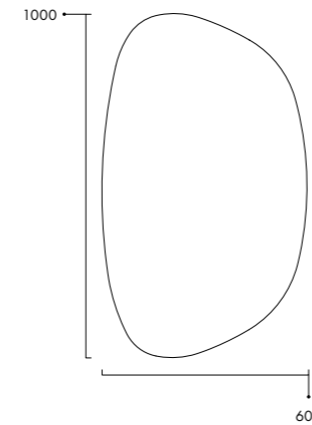



# SORA

## FEATURES

- Seamless LED lighting
- Superior colour rendering: CRI 90
- High-density design: 240 LEDs/m
- LED Lifetime >54,000h L80
- Adjustable colour temperature: 2700K – 6500K
- Guardian Glass UltraMirror® Plus
- Demister
- 1 hour power saving cut off
- RCM certified IP44 rated ModuBox
- Backlit
- 5 Year replacement warranty

## CONTROL OPTIONS



Touch Sensor



Hand Wave Sensor

## OPTIONAL ADD-ONS



Bluetooth Speakers



Mirage Magnifier

## SIZES + PRICING

	CODE	RRP INC GST
<b>1 CHOOSE YOUR SIZE</b> 1400x1000	SRA140D	\$975.00
<b>2 CHOOSE A CONTROL</b> Touch Sensor with Guide Light	C1	-
Hand Wave Sensor	C2	-
<b>3 CHOOSE ADD-ONS</b> Bluetooth Speakers	BT	\$159.00
Mirage Magnifier	AMX5MW	\$199.00

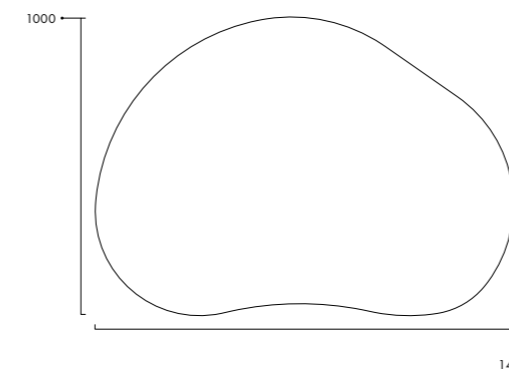



# LANI

## FEATURES

- Seamless LED lighting
- Superior colour rendering: CRI 90
- High-density design: 240 LEDs/m
- LED Lifetime >54,000h L80
- Adjustable colour temperature: 2700K – 6500K
- Guardian Glass UltraMirror® Plus
- Demister
- 1 hour power saving cut off
- RCM certified IP44 rated ModuBox
- Backlit
- 5 Year replacement warranty

## CONTROL OPTIONS

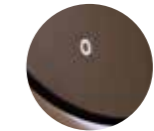

Touch Sensor

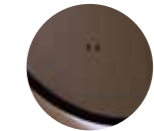

Hand Wave Sensor

## OPTIONAL ADD-ONS



Bluetooth Speakers

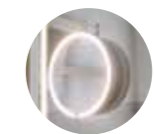

Mirage Magnifier

## SIZES + PRICING

	CODE	RRP INC GST
<b>1 CHOOSE YOUR SIZE</b> 1100x800	LA110D	\$869.00
<b>2 CHOOSE A CONTROL</b> Touch Sensor with Guide Light Hand Wave Sensor	C1	-
	C2	-
<b>3 CHOOSE ADD-ONS</b> Bluetooth Speakers Mirage Magnifier	BT	\$159.00
	AMX5MW	\$199.00

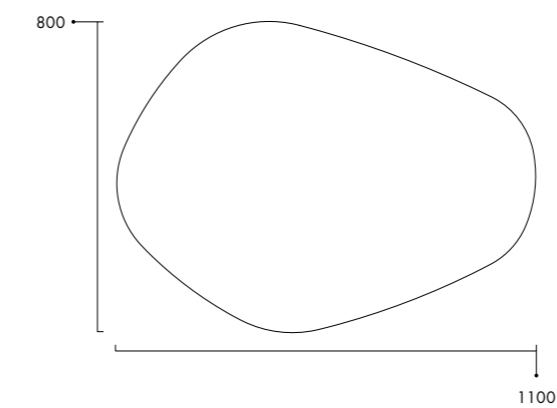



# COLOURED GLASS MIRRORS

REFLECTION WITH **ATMOSPHERE**



# COLOURED GLASS S-SERIES

## FEATURES

- Seamless LED lighting
- Superior colour rendering: CRI 90
- High-density design: 240 LEDs/m
- LED Lifetime >54,000h L80
- Adjustable colour temperature: 2700K – 6500K
- Demister
- 1 hour power saving cut off
- RCM certified IP44 rated ModuBox
- Backlit
- Select glass colour
- 5 Year replacement warranty

## CONTROL OPTIONS

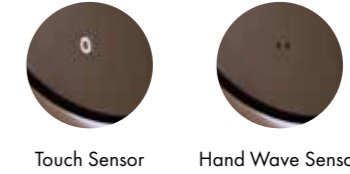

## OPTIONAL ADD-ONS



## SIZES + PRICING

	CODE	RRP INC GST
<b>1 CHOOSE YOUR DESIGN &amp; SIZE</b>		
600x600 Bronzed Glass	SNB60D	\$439.00
600x600 Smoked Glass	SNS60D	\$439.00
800x800 Bronzed Glass	SNB80D	\$619.00
800x800 Smoked Glass	SNS80D	\$619.00
<b>2 CHOOSE A CONTROL</b>		
Touch Sensor with Guide Light	C1	-
Hand Wave Sensor	C2	-
<b>3 CHOOSE ADD-ONS</b>		
Bluetooth Speakers	BT	\$159.00
Mirage Magnifier	AMX5MW	\$199.00

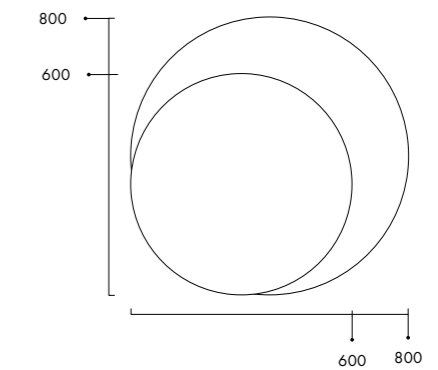
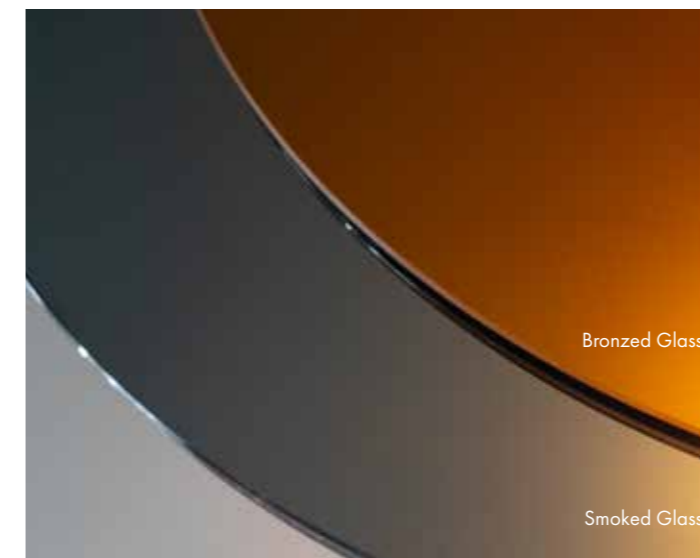

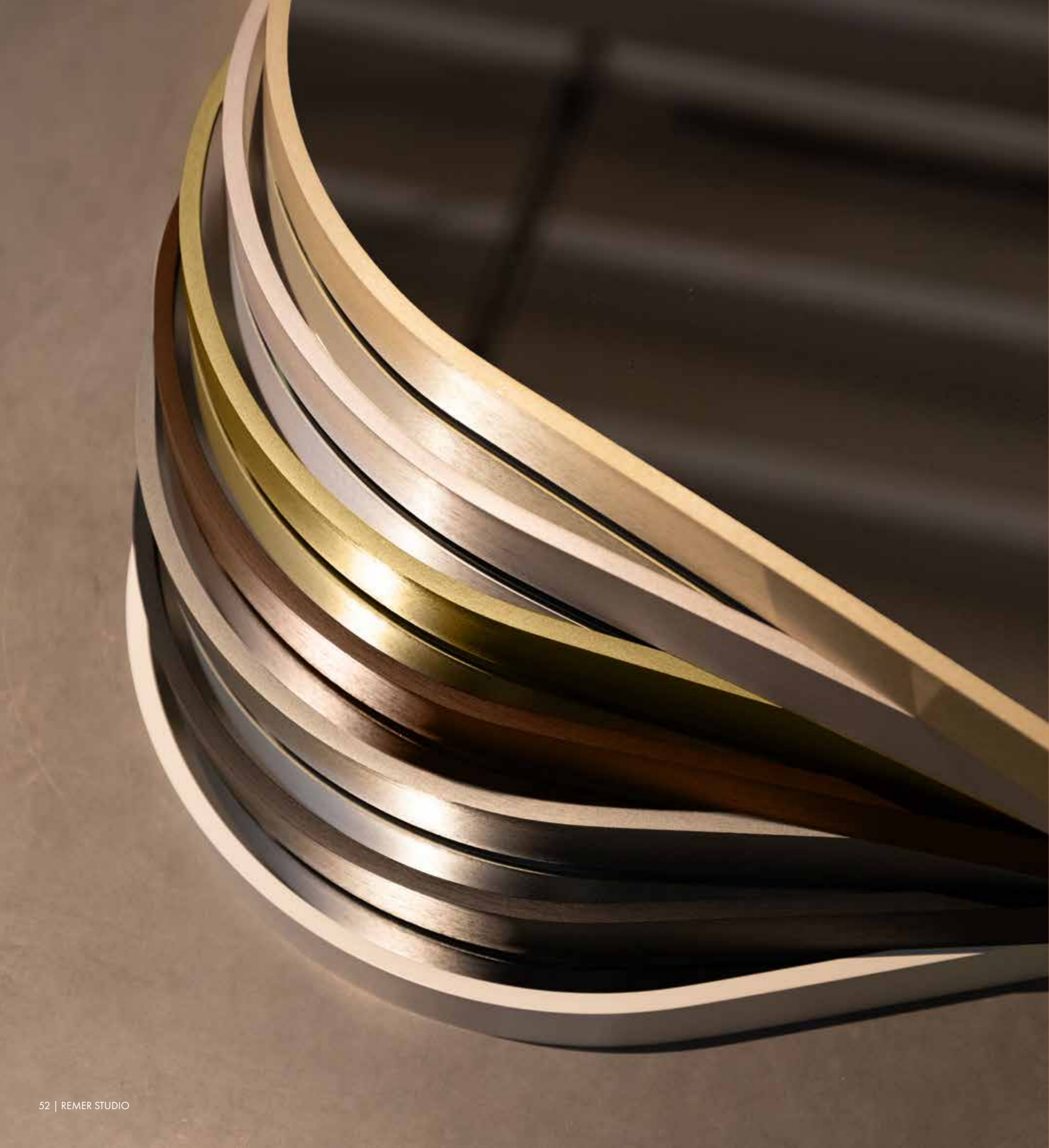

# FRAMED MIRRORS

**DEFINED EDGES  
THAT INTRODUCE  
STRUCTURE AND  
PRESENCE.**



# FRAMED A-SERIES

FRAMED

## FEATURES

- Superior colour rendering: CRI 90
- LED Lifetime >54,000h L80
- Adjustable colour temperature: 2700K – 6500K
- Demister
- 1 hour power saving cut off
- IP44
- Backlit
- 5 Year replacement warranty

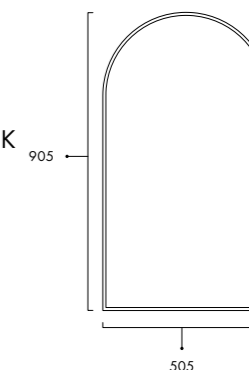

## FRAME COLOUR OPTIONS

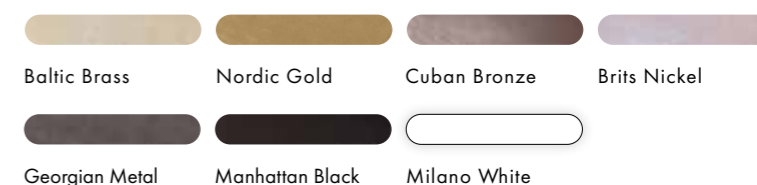

## CONTROL OPTIONS

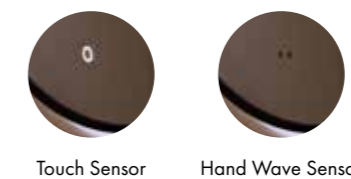

## OPTIONAL ADD-ONS

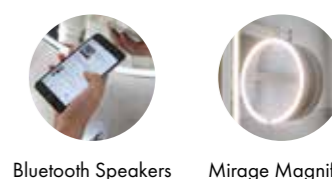

## SIZES + PRICING

	CODE	RRP INC GST
<b>1 CHOOSE YOUR SIZE &amp; FRAME COLOUR</b>		
Size	505x905	AN50DF
		\$589.00
Frame	Baltic Brass	BB
	Nordic Gold	NG
	Cuban Bronze	CB
	Brits Nickel	BN
	Georgian Metal	GM
	Manhattan Black	MB
	Milano White	MW
		-
<b>2 CHOOSE A CONTROL</b>		
	Touch Sensor with Guide Light	C1
	Hand Wave Sensor	C2
		-
<b>3 CHOOSE ADD-ONS</b>		
	Bluetooth Speakers	BT
	Mirage Magnifier	AMX5MW
		\$159.00
		\$199.00





# FRAMED O-SERIES

## FEATURES

- Superior colour rendering: CRI 90
- LED Lifetime >54,000h L80
- Adjustable colour temperature: 2700K – 6500K
- Demister
- 1 hour power saving cut off
- IP44
- Backlit
- 5 Year replacement warranty

## FRAME COLOUR OPTIONS

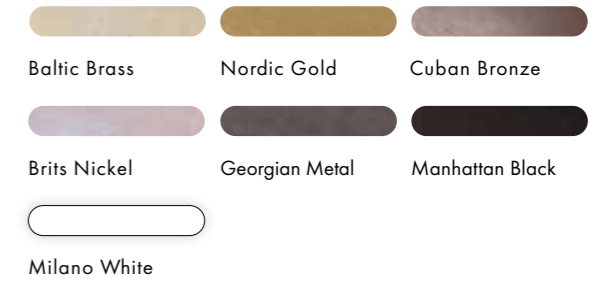

## CONTROL OPTIONS

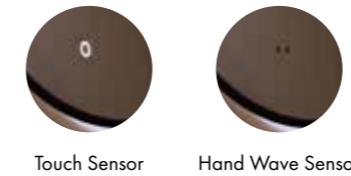

## OPTIONAL ADD-ONS



## SIZES + PRICING

	CODE	RRP INC GST	
<b>1 CHOOSE YOUR SIZE &amp; FRAME COLOUR</b>			
Size	455x905	ON45DF	\$589.00
Frame	Baltic Brass	BB	-
	Nordic Gold	NG	-
	Cuban Bronze	CB	-
	Brits Nickel	BN	-
	Georgian Metal	GM	-
	Manhattan Black	MB	-
	Milano White	MW	-
<b>2 CHOOSE A CONTROL</b>			
	Touch Sensor with Guide Light	C1	-
	Hand Wave Sensor	C2	-
<b>3 CHOOSE ADD-ONS</b>			
	Bluetooth Speakers	BT	\$159.00
	Mirage Magnifier	AMX5MW	\$199.00

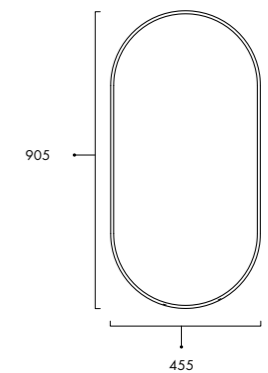

PICTURED: O-Series with Baltic Brass frame



# FRAMED I-SERIES

FRAMED

## FEATURES

- Superior colour rendering: CRI 90
- LED Lifetime >54,000h L80
- Adjustable colour temperature: 2700K – 6500K
- Demister
- 1 hour power saving cut off
- IP44
- Backlit
- 5 Year replacement warranty

## FRAME COLOUR OPTIONS

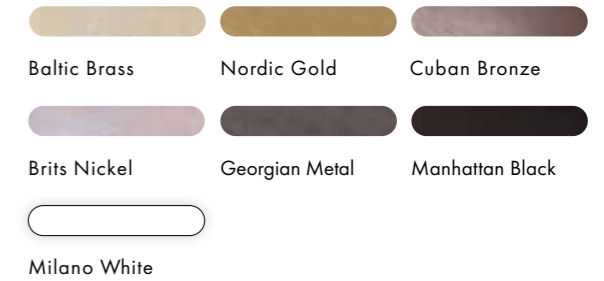

## CONTROL OPTIONS

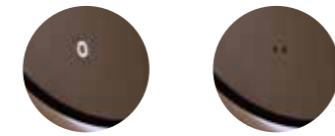

Touch Sensor    Hand Wave Sensor

## OPTIONAL ADD-ONS



Bluetooth Speakers    Mirage Magnifier

## SIZES + PRICING

	CODE	RRP INC GST
<b>1 CHOOSE YOUR SIZE &amp; FRAME COLOUR</b>		
Size	455x905	IN45DF \$589.00
	605x1005	IN60DF \$629.00
Frames	Baltic Brass	BB -
	Nordic Gold	NG -
	Cuban Bronze	CB -
	Brits Nickel	BN -
	Georgian Metal	GM -
	Manhattan Black	MB -
	Milano White	MW -
<b>2 CHOOSE A CONTROL</b>		
	Touch Sensor with Guide Light	C1 -
	Hand Wave Sensor	C2 -
<b>3 CHOOSE ADD-ONS</b>		
	Bluetooth Speakers	BT \$159.00
	Mirage Magnifier	AMX5MW \$199.00

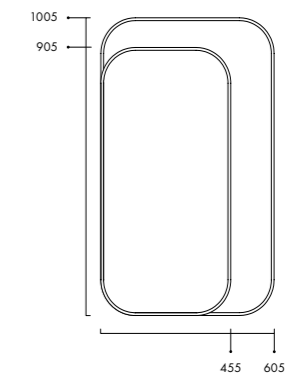



# FRAMED R-SERIES

FRAMED

## FEATURES

- Superior colour rendering: CRI 90
- LED Lifetime >54,000h L80
- Adjustable colour temperature: 2700K – 6500K
- Demister
- 1 hour power saving cut off
- IP44
- Backlit
- 5 Year replacement warranty

## FRAME COLOUR OPTIONS

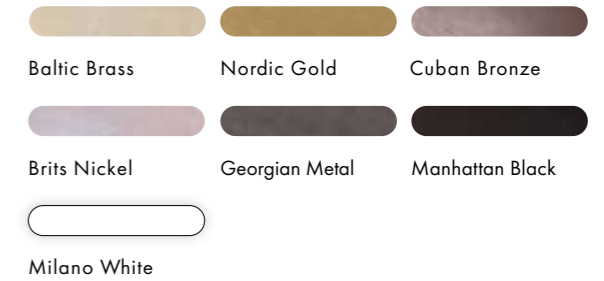

## CONTROL OPTIONS

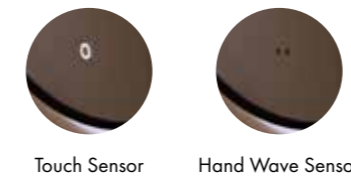

## OPTIONAL ADD-ONS

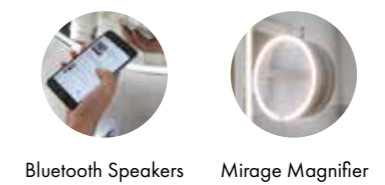

## SIZES + PRICING

### 1 CHOOSE YOUR SIZE & FRAME COLOUR

	CODE	RRP INC GST
Size	605x905 (Portrait)	RN60DF \$629.00
	905x605 (Landscape)	RN90DF \$629.00
	1205x755 (Landscape)	RN120DF \$739.00
Frame	Baltic Brass	BB -
	Nordic Gold	NG -
	Cuban Bronze	CB -
	Brits Nickel	BN -
	Georgian Metal	GM -
	Manhattan Black	MB -
	Milano White	MW -

### 2 CHOOSE A CONTROL

Touch Sensor with Guide Light	C1	-
Hand Wave Sensor	C2	-

### 3 CHOOSE ADD-ONS

Bluetooth Speakers	BT	\$159.00
Mirage Magnifier	AMX5MW	\$199.00

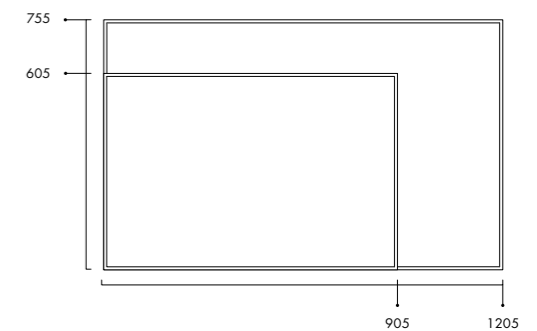
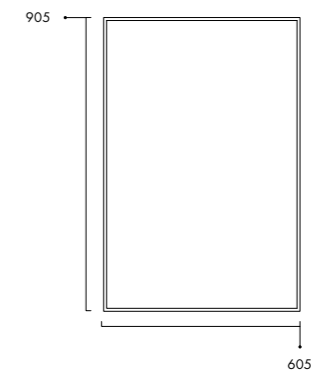



# FRAMED S-SERIES

FRAMED

## FEATURES

- Superior colour rendering: CRI 90
- LED Lifetime >54,000h L80
- Adjustable colour temperature: 2700K – 6500K
- Demister
- 1 hour power saving cut off
- IP44
- Backlit
- 5 Year replacement warranty

## FRAME COLOUR OPTIONS

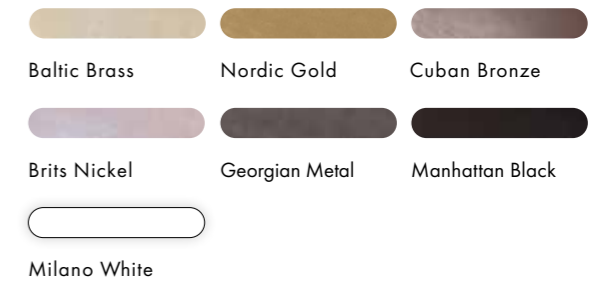

## CONTROL OPTIONS

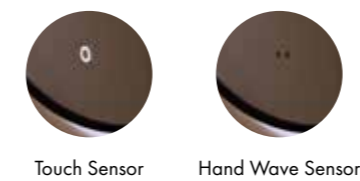

## OPTIONAL ADD-ONS

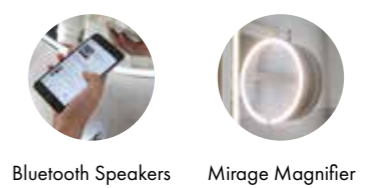

## SIZES + PRICING

	CODE	RRP INC GST
<b>1 CHOOSE YOUR SIZE &amp; FRAME COLOUR</b>		
Sizes	605x605	SN60DF \$439.00
	805x805	SN80DF \$619.00
Frame	Baltic Brass	BB -
	Nordic Gold	NG -
	Cuban Bronze	CB -
	Brits Nickel	BN -
	Georgian Metal	GM -
	Manhattan Black	MB -
	Milano White	MW -
<b>2 CHOOSE A CONTROL</b>		
	Touch Sensor with Guide Light	C1 -
	Hand Wave Sensor	C2 -
<b>3 CHOOSE ADD-ONS</b>		
	Bluetooth Speakers	BT \$159.00
	Mirage Magnifier	AMX5MW \$199.00

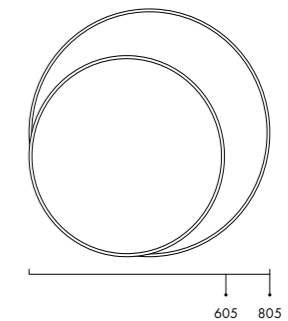



# THE REMER CUSTOM EXPERIENCE

The Remer Custom Experience allows you to create a mirror tailored to your exact requirements. From shape and size to lighting and features, each piece is designed to complement your space with precision and intent.

Crafted locally in Melbourne using premium materials and advanced mirror technology, every custom mirror reflects both innovation and individuality.

Work with an authorised Remer reseller to bring your design to life.

Scan to view the full custom process and create your mirror.



- All prices are Recommended Retail Price (RRP) including GST. Prices may vary depending on location and are subject to change or correction without notification.
- Made-to-order cannot be cancelled, altered, exchanged or refunded unless faulty or damaged.
- Sizes are in mm and nominal and should be checked prior to installation.
- Please note all LED Products requiring hardwiring must be installed by a licensed electrician in accordance with local regulations.
- Actual colours may vary so please check colour samples before ordering.
- Images in this brochure are shown with accessories and other furniture which is not included in the price.
- Lead times are estimates only and may vary depending on product selection, order volume, production requirements, and factors outside of our control.
- All information is provided on an E&OE basis (Errors and Omissions Excepted). There is a huge amount of very useful information in this brochure and there is more than likely an error, big or small, somewhere.

## MANUFACTURER'S WARRANTY

At Remer Pty Ltd (Remer), we pride ourselves on supplying products of a high industry standard and quality. Our goods come with guarantees that cannot be excluded under the Australian Consumer Law. You are entitled to a replacement or refund for a major failure and compensation for any other reasonably foreseeable loss or damage. You are also entitled to have the goods repaired or replaced if the goods fail to be of acceptable quality and the failure does not amount to a major failure.

### Studio Mirror Collection

5 years replacement parts or products for domestic use. 1 year replacement parts or products for commercial use. Labour is not included.

### Mirage Portable Magnifier

1 year replacement for Mirage Portable Magnifier.

For full warranty information scan QR Code:



For other resources including user and installation manuals, please visit our resources page

REMER

STUDIO 26/27

Head Office: 13-15 Edison Road  
Dandenong South VIC 3175

+61 3 9706 6663  
[sales@remer.com.au](mailto:sales@remer.com.au)  
[remer.com.au](http://remer.com.au)